

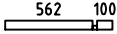

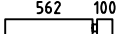





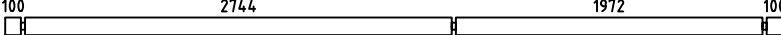
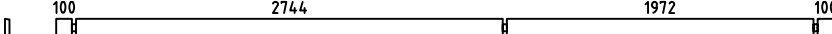
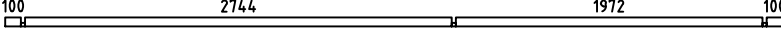
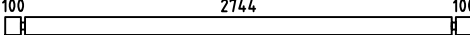
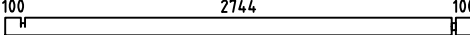
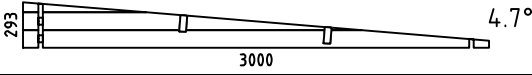
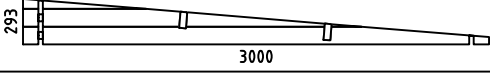
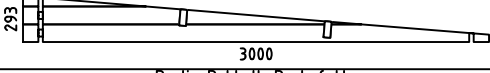
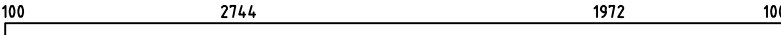

Pos	Specification-Spezifikation-Specificatie	St.	Profile (mm)	Length (mm)
001		2	28x57	690
002		32	28x114	690
003		16	28x114	315
004		16	28x114	5000
005		2	28x114	5000
006		1	28x57	5000
007		32	28x114	3000
011		1	28x114	3000
WA-1		1		
WB-1		1		
WC-1		1		
PR1		2	44x144	5000
DP1	Roof board-Dachbrett-Dakplank 	57	88x18	3250
	-POST 85x85 	1		2005
L1	Eave Board-Traufenblende-Afdekplank 	2	18x120	5036
L2	Facia Board-Giebelblende-Gevelplank 	2	18x120	3290
	Adjustable foot-Stellfuß+Schrauben 4x50 4stück für Post 	1		
	Double Door Set-Doppeltür Satz-Dubbele Deur Set 	1		
	Nail-Nagel-Spijker 1.2x20 	15		
DD6 1 60X185	DOOR 1600x1850  Door Glazing Bar Türsprossen Deurroeden 	1		
Kood	Materjal	File	Dora28.dwg	Leht 1/1

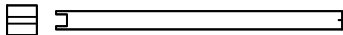

Model	Dor-a28	Page	PLAN
Client		Scale	1:30
Material	28x114,mm	Date	11.05.2017
Company		File	Dora28.dwg

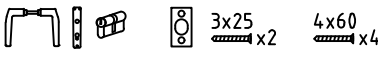

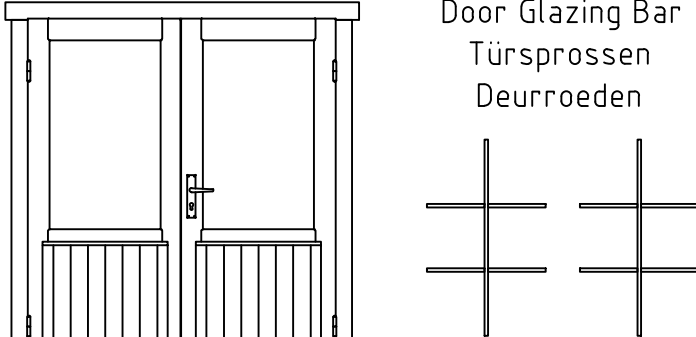
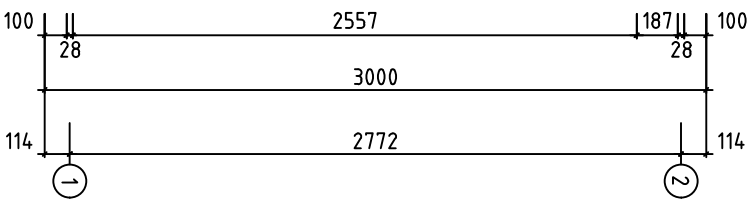
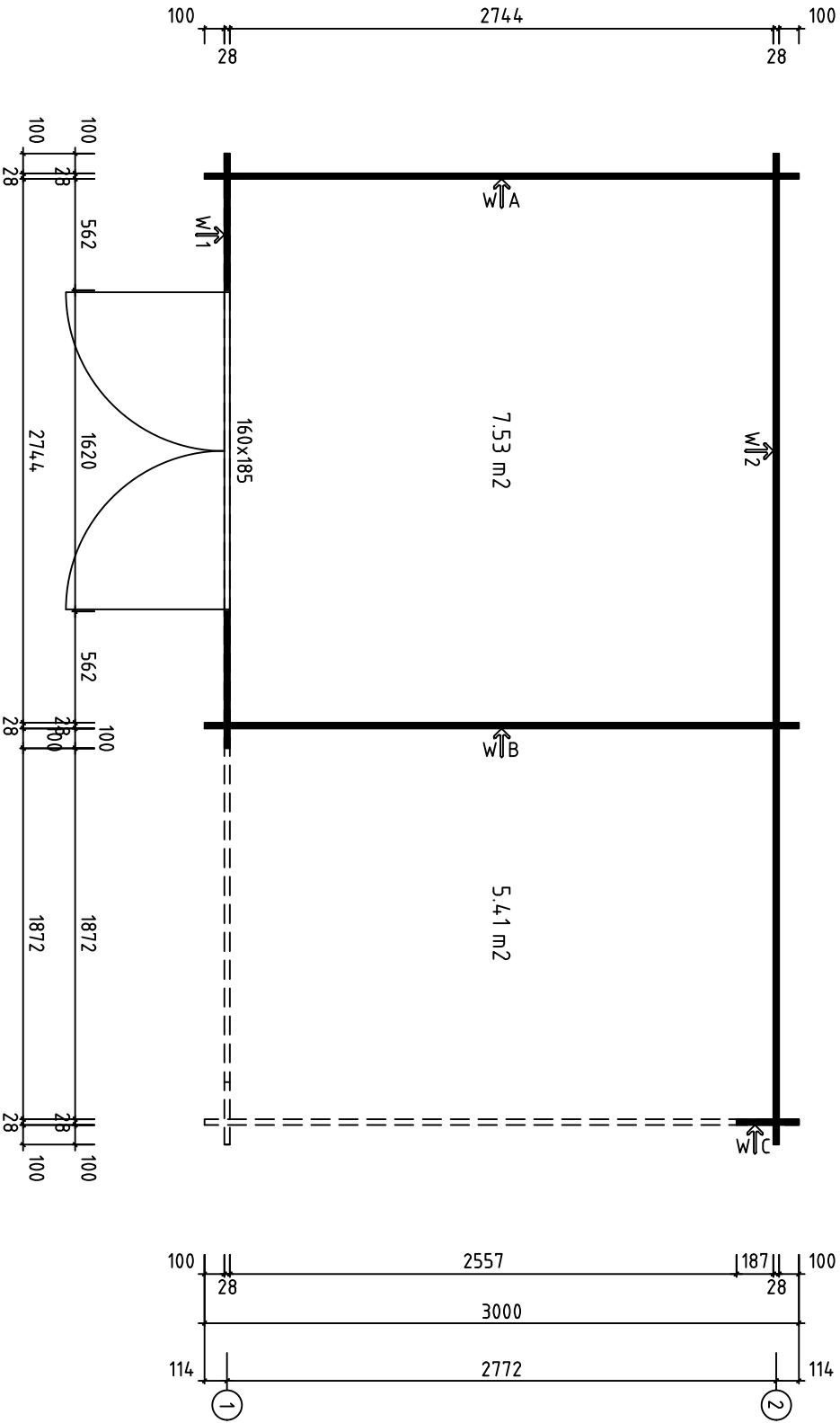
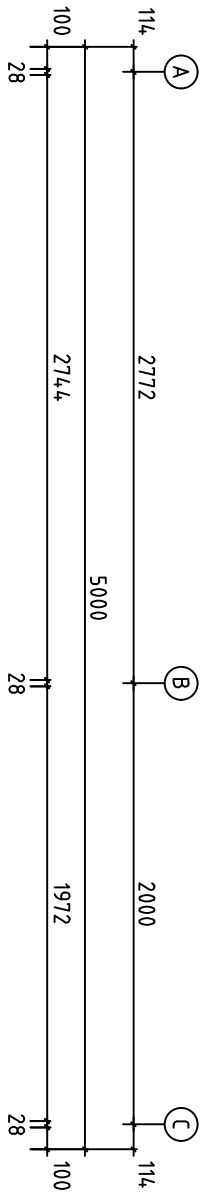
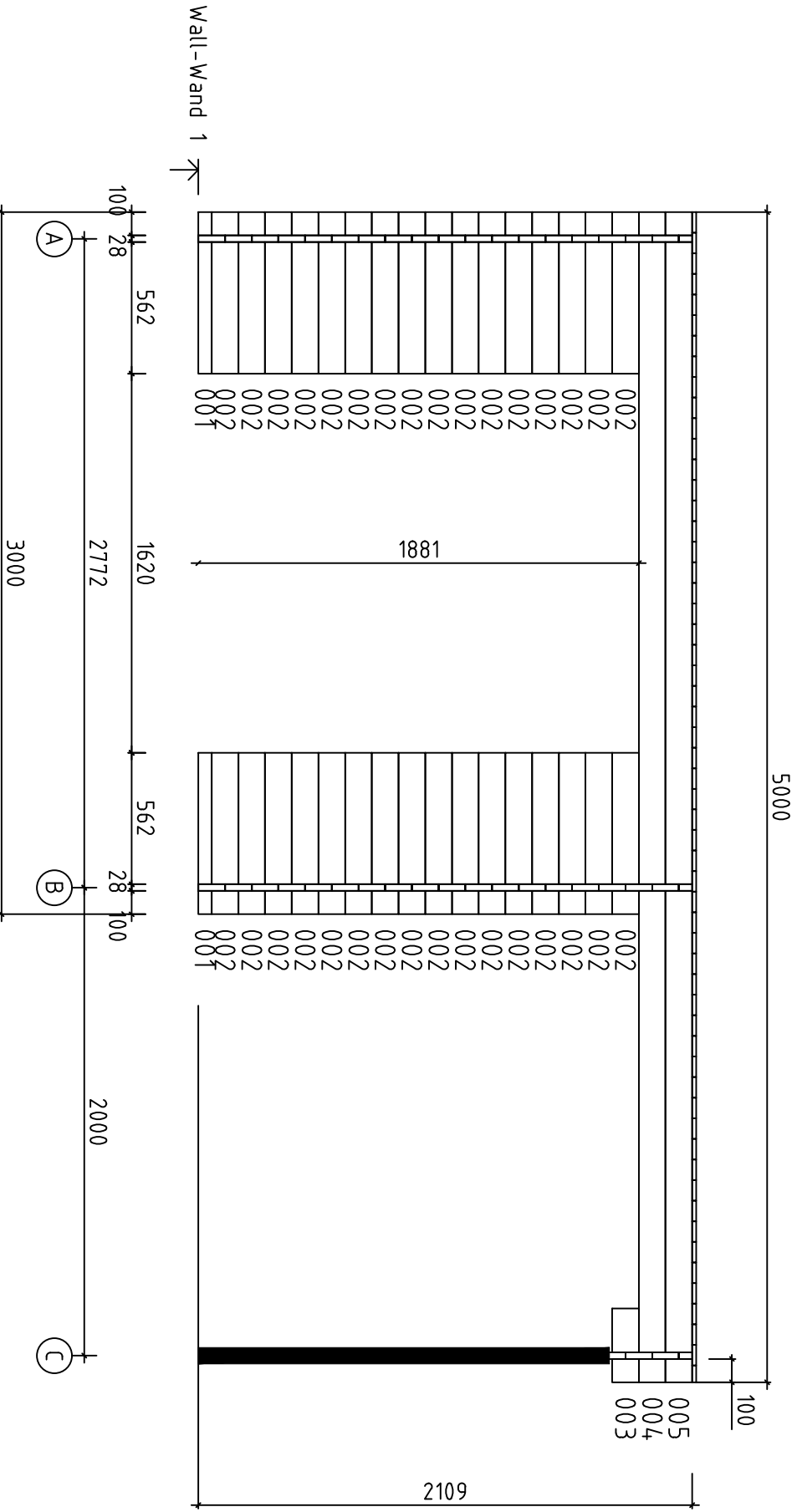
Model	Dora28	Page	5
Client		Scale	1:30
Material	2.8X11.4	Date	11.05.2017
Company		File	Dora28.dwg





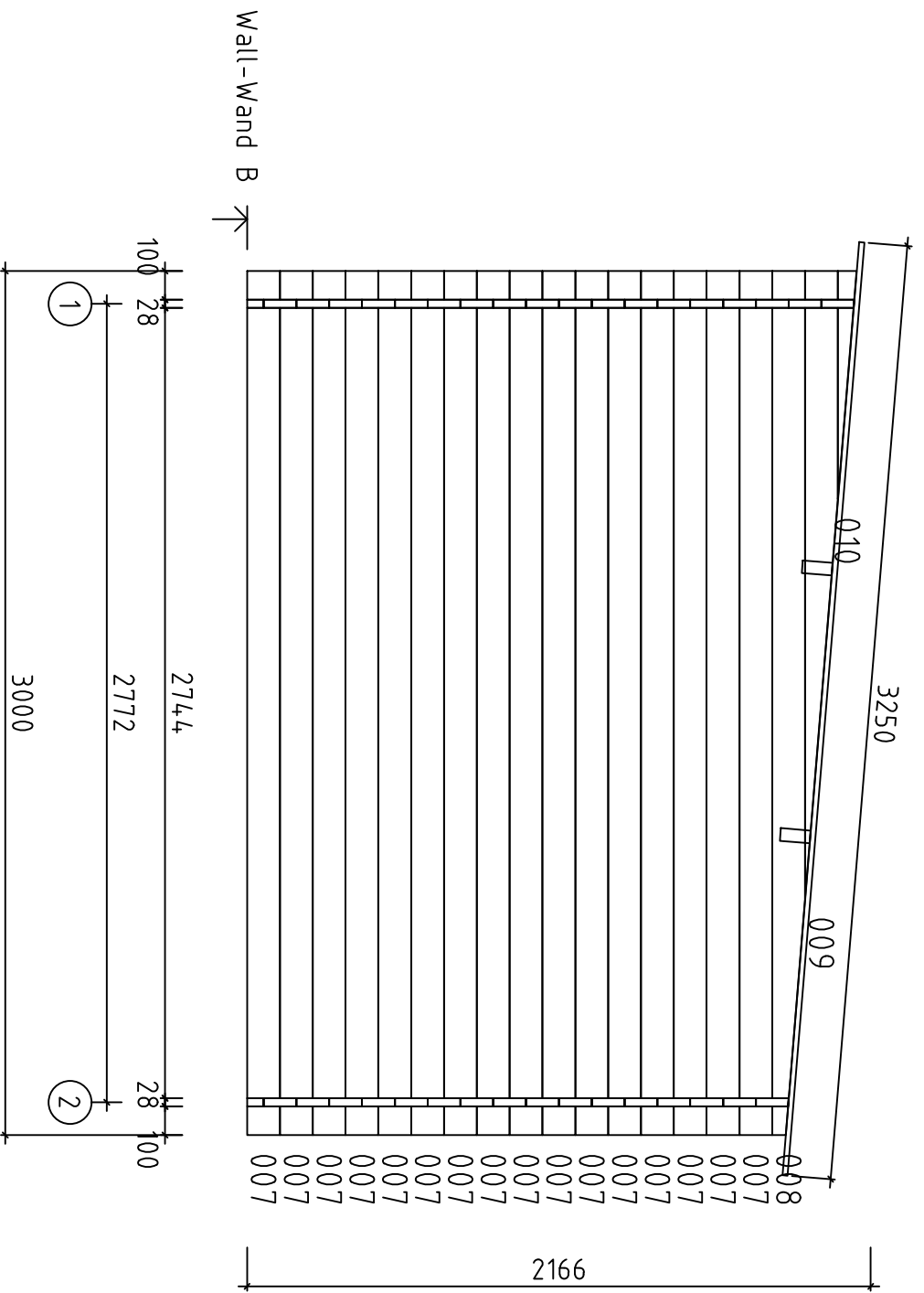

Model	Dora28	Page	3
Client		Scale	1:30
Material	2.8x11.4	Date	11.05.2017
Company		File	Dora28.dwg





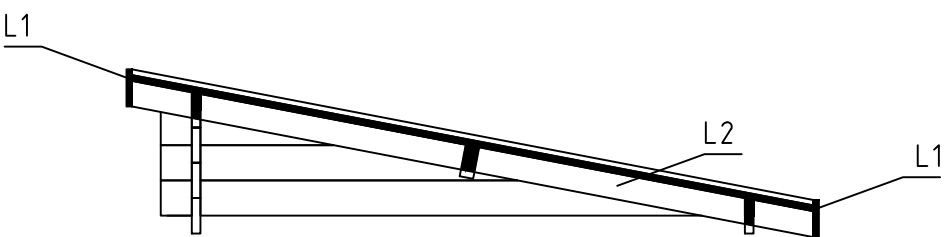
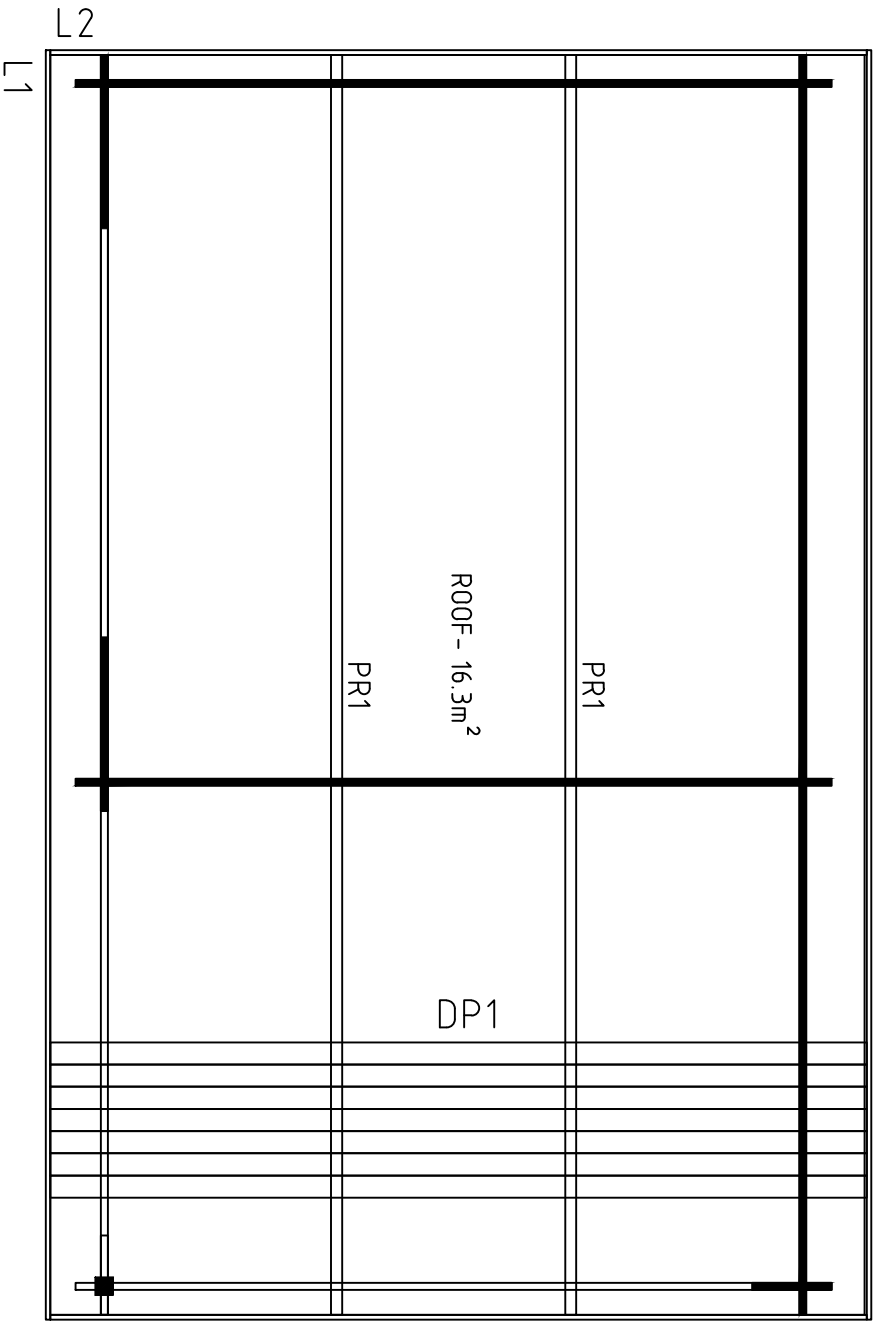

Model	Dor28	Page
Client		Scale
Material	28x114mm	Date
Company		File
		Dor28.dwg
		1:30
		11.05.2017

The guide is illustrative. This guide is not project specification.  
 Der Leitfaden ist illustrativ. Dieser Leitfaden ist keine Projektspezifikation.  
 De gids is illustratief. Deze gids is geen projectspecificatie.

MA-1	32	2000	1
MA-1	32	2000	1
MB-1	32	2000	1

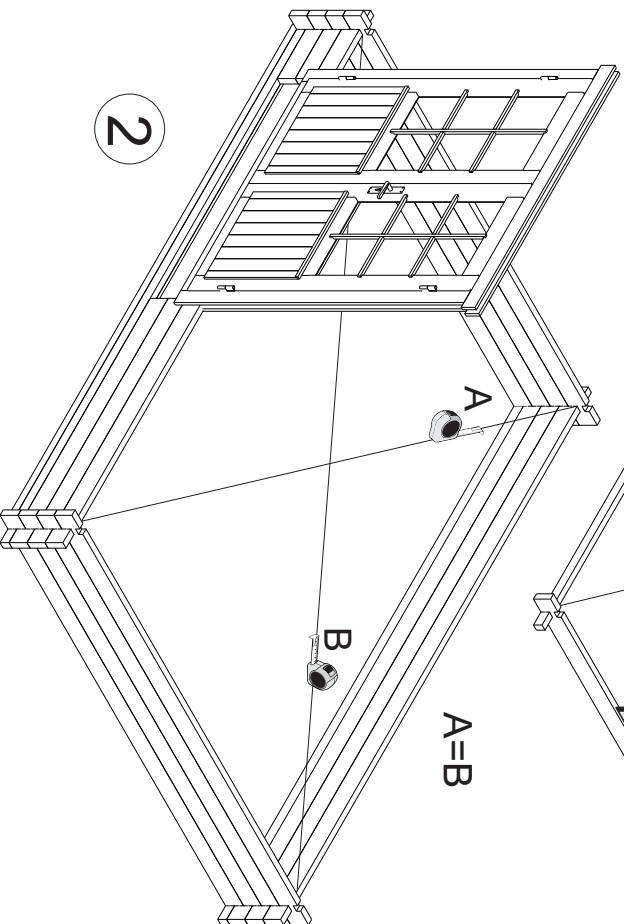
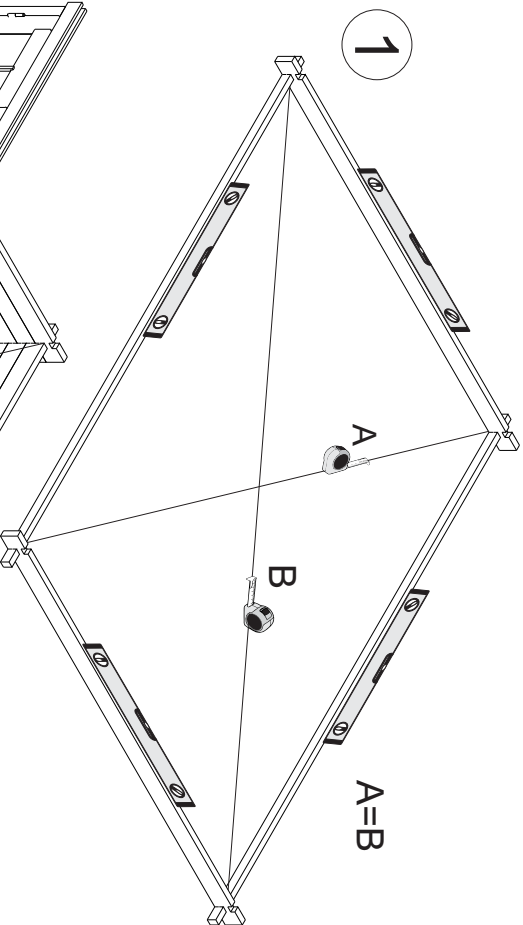
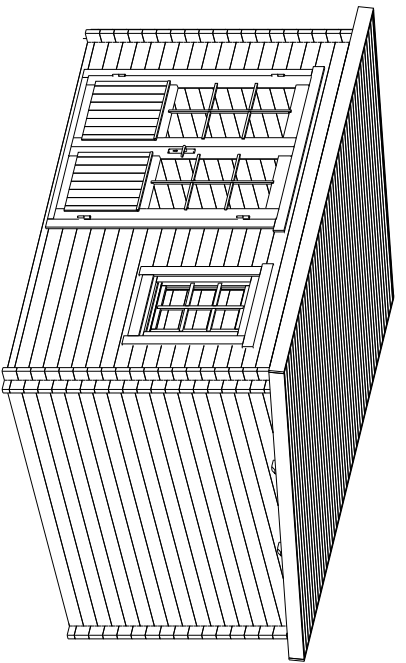
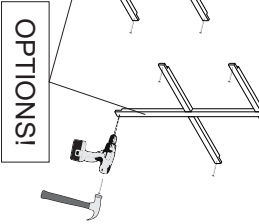
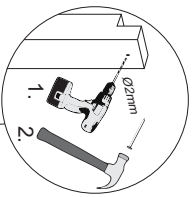
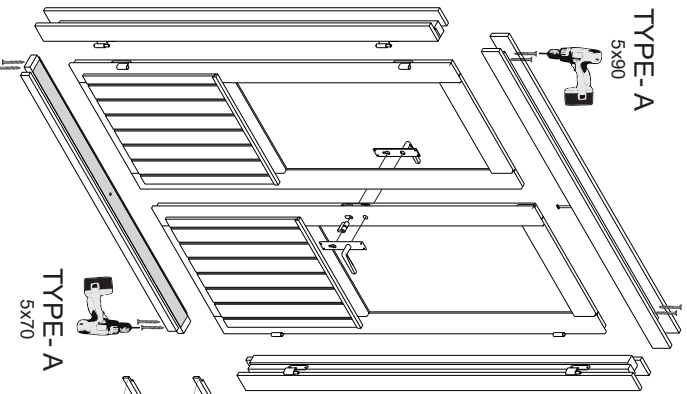
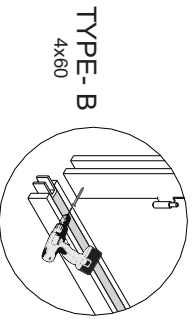
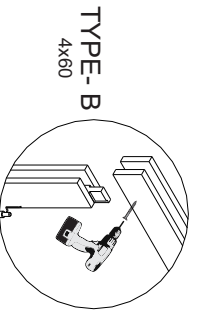
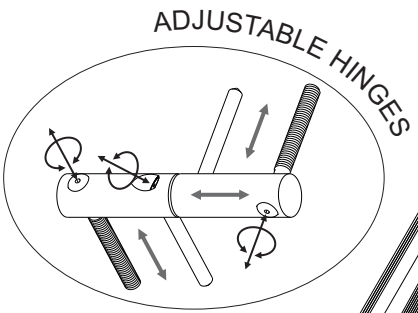
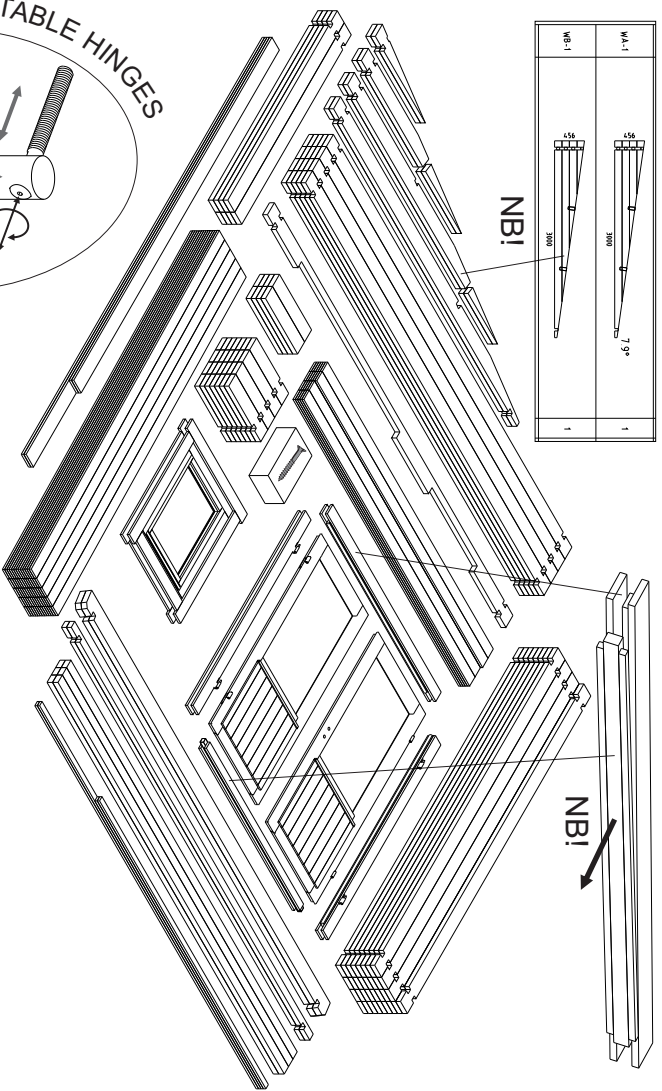

3

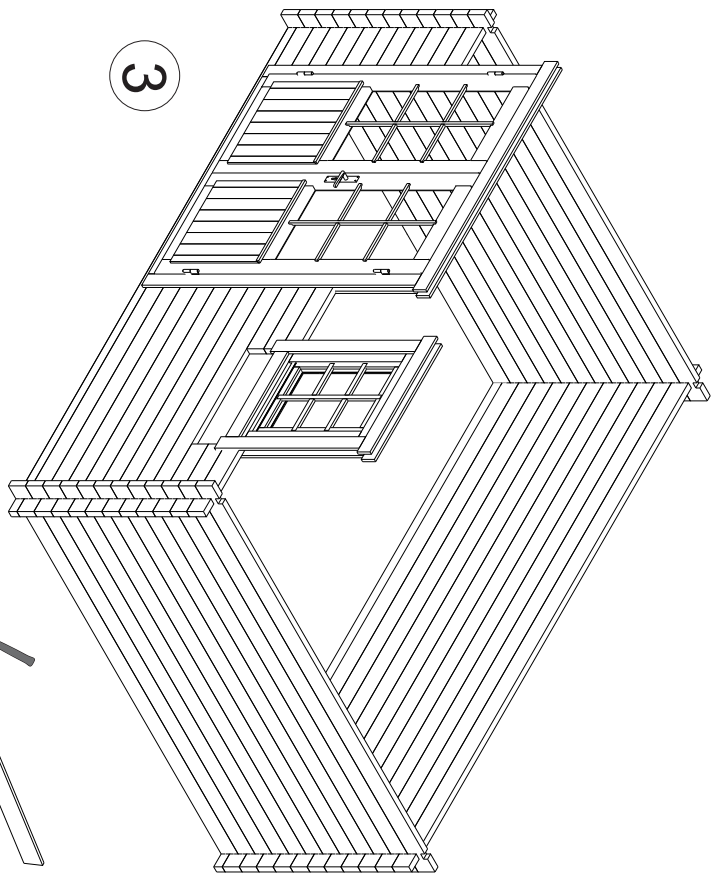

4

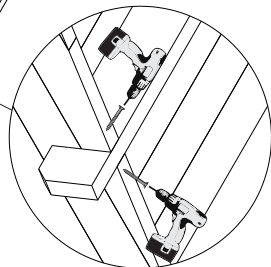
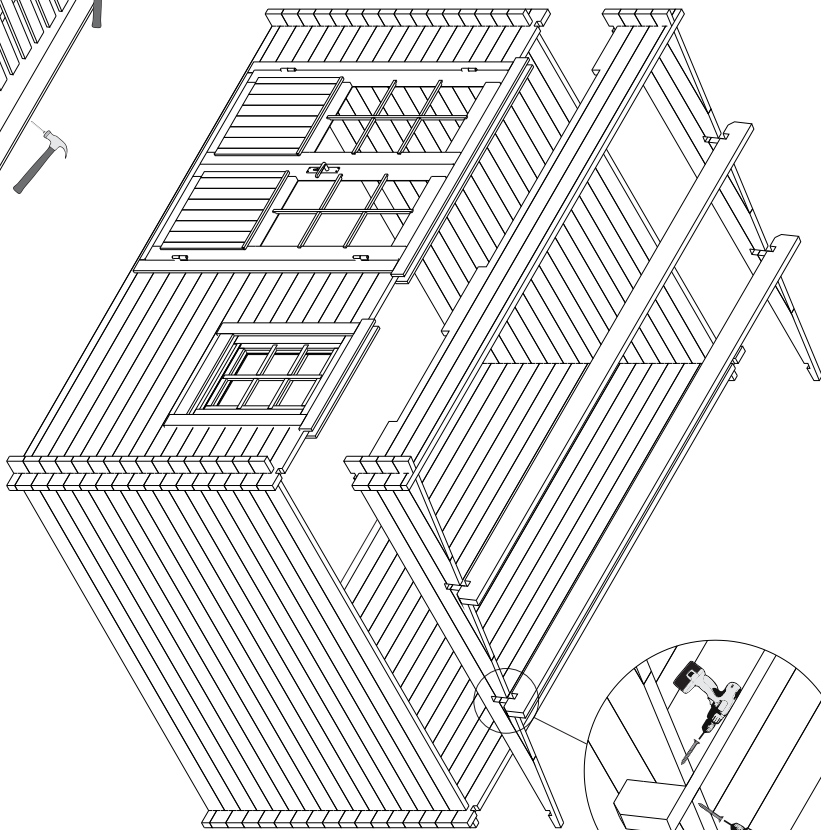

5

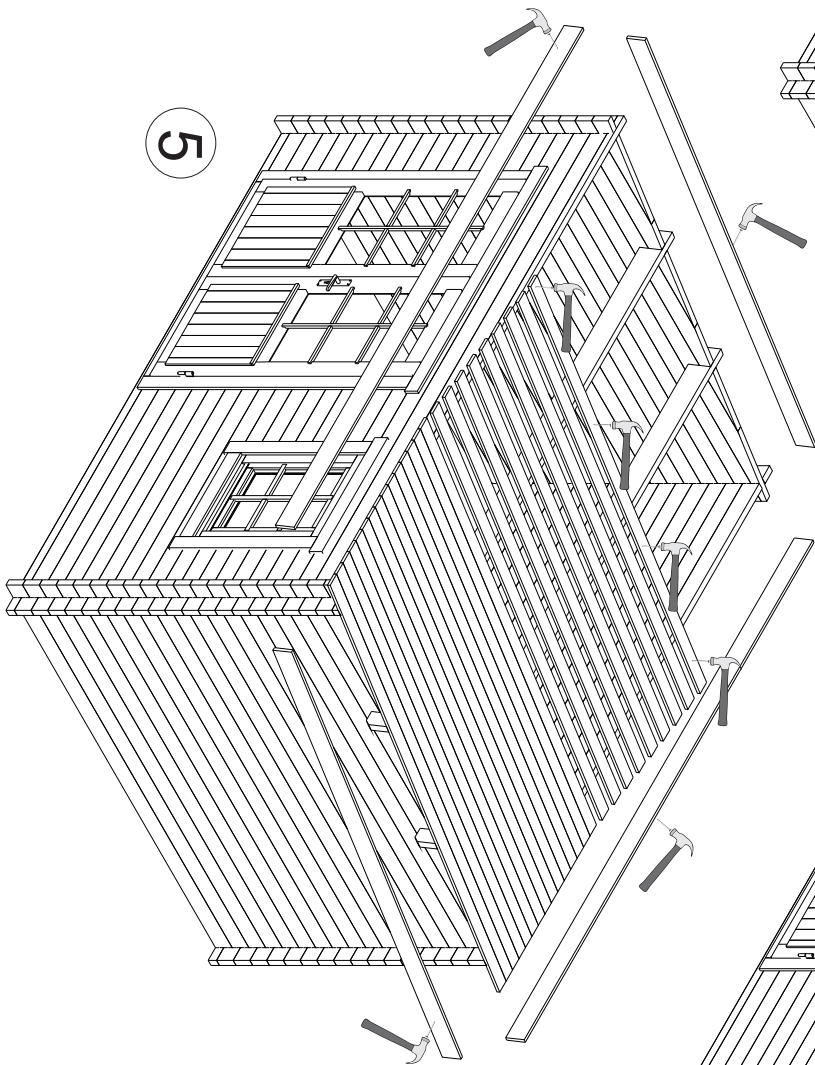

## Cutting support post / Schneiden der Stützpfosten



- \* Adjustment space for post support should be at least 50mm.
- \* Einstellraum für die Pfostenstütze muss mindestens 50mm sein.

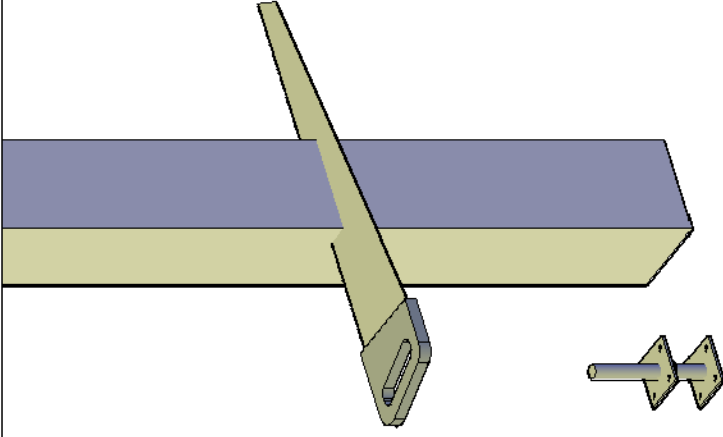

- \* Support post has extra length for various conditions. Must be sawn to suitable length on spot considering local conditions.
- \* Stützpfosten hat extra Länge für verschiedene Bedingungen. Muss vor Ort unter Berücksichtigung der örtlichen Gegebenheiten zu einer geeigneten Länge gesägt werden.

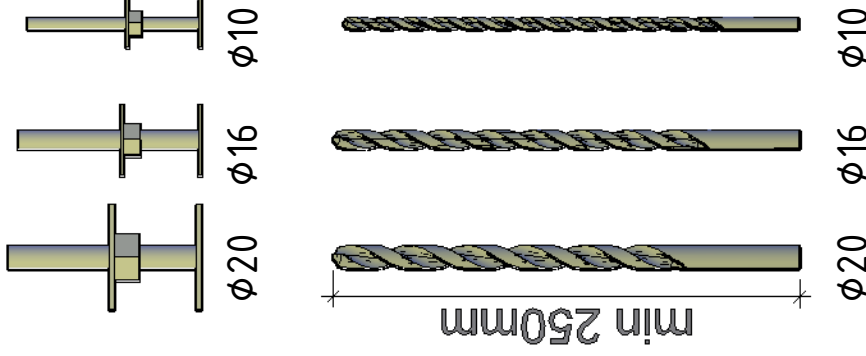

- \* In some cases you need to drill a new hole for a post support. Find a matching drill bit.
- \* In einigen Fällen müssen Sie ein neues Loch für die Pfostenstütze bohren. Finden Sie hier den passenden Bohrer.

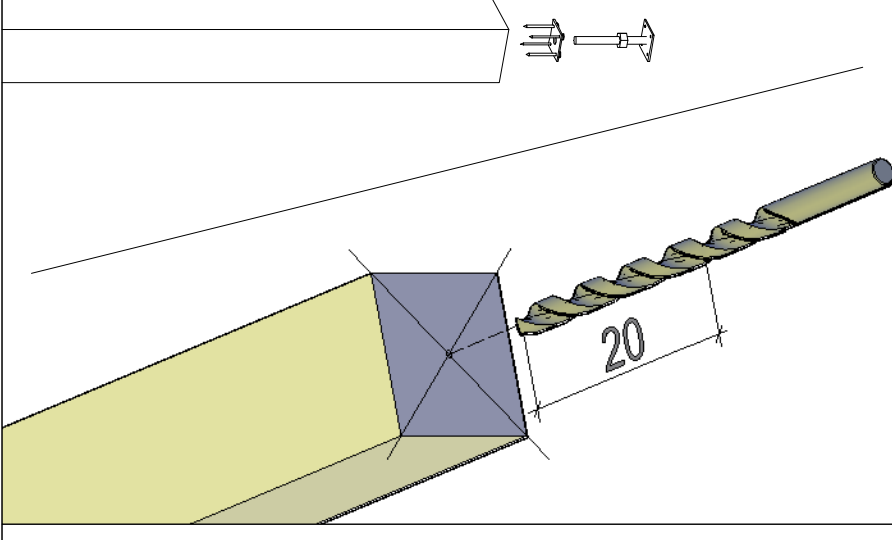

- \* Mark the center of the post and drill a new 20cm deep hole.
- \* Continue building.
- \* Markieren Sie die Mitte des pfostens und bohren Sie ein neues 20cm tiefes Loch. Danach mit Aufbau weiter machen.